

## Quick Installation Guide

### 1. Tools Required

The following tools will be required to install CM (Master) and CS (Slave).



### 2. Packing List

For CS :

No.	Items
A	Mounting screw pack
B	Installation guide & User manual

For CM :

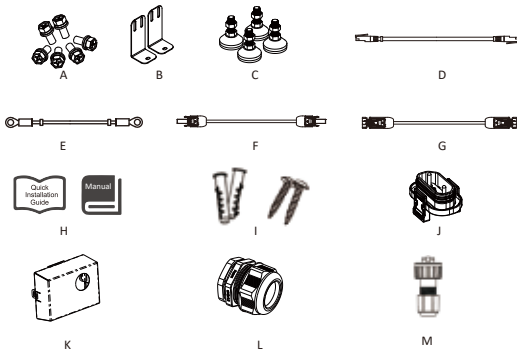

No.	Items	No.	Items
A	Mounting screw pack	H	Installation guide & User manual
B	Fixing bracket	I	Expansion tube*2 & Expansion screw*2
C	Footstand	J	Waterproof cover
D	Communication cable (BMS-inverter)	K	Junction box
E	Grounding cable	L	Cable gland
F	DC positive output cable	M	RJ45
G	DC negative output cable		

### 3. Terminals

For CS :

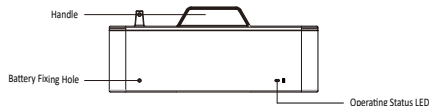

For CM :

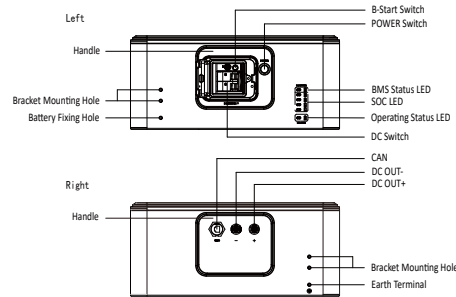

### 4. Installation Steps

#### Step 1

Install a CS with four footstand (Item C) and place it on the ground and adjust it to the level. After installing the feetstand, use a track level bar to confirm the level. Insert the waterproof cover (Item J) into the bottom of the battery and lock it in place with the clip.

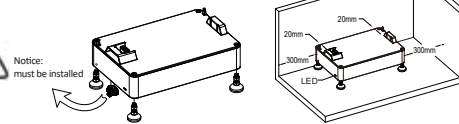

#### Step 3

Stack the batteries one by one.

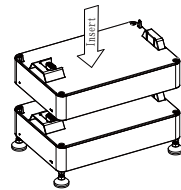

#### Step 5

Mark the wall through the bracket hole.

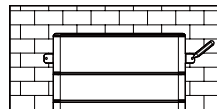

#### Step 2

Place the battery 20mm against the wall. Note: Please make sure the Operating Status LED is on your left handside when you facing the battery model.

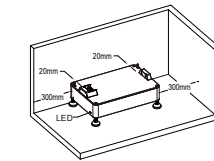

#### Step 4

Place the two fixing brackets (Item B) close to the wall and install them on both sides of the battery.

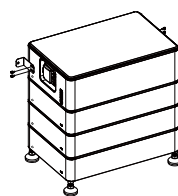

#### Step 6

Punch after removing the CM. Drill holes with electric drill, make sure the holes are at least 50mm deep, and then tighten the expansion tubes (Item I).

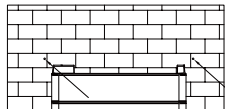

#### Step 7

After stacking CM again, fix the battery on the wall.

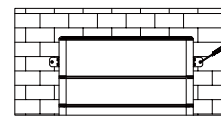

#### Step 8

Fix the mounting screw packs on both sides of the battery, the installation is over.

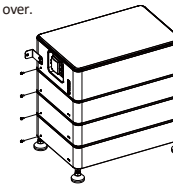

Note: Please make sure each system including 1 CM and 1 CS. CS less than 6 pieces:

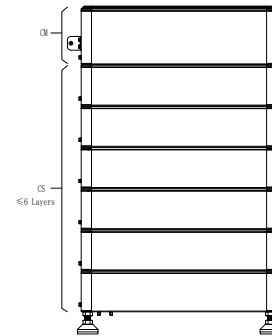

Please refer to the video for the installation of the junction box and the cable gland.

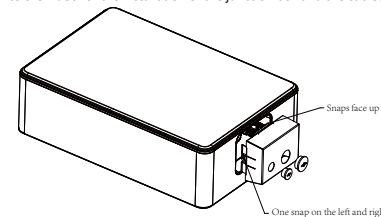

### 5. Wiring Steps

A: Connect the inverter and make sure the wiring position is correct, as shown in the figure below.

Note: Inverter wiring refer to the inverter user manual.

**For outdoor use, please use item H and proceed as follows**

Connection steps:

Step 1: Prepare a standard network cable and cable connector, then insert the network cable through the cable connector.



Step 2: Crimp the cable with a RJ45 plug which is inside of the cable connector.

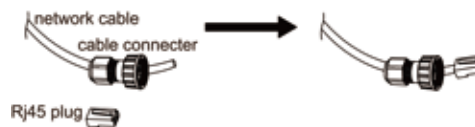

**If the usage is indoor, please use item D**

Step 3: Insert the cable connector into BMS port at the bottom of inverter and screw it tightly.

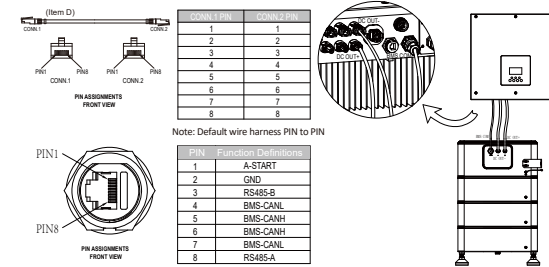

B: Connect the grounding cable. The figure is shown in below.

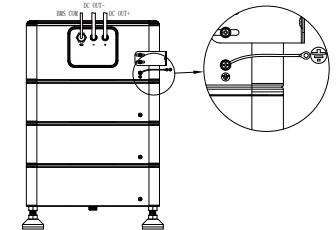

### 6. System Start Up

CM operation:

- Normal mode: When there is PV and grid access, turn on DC switch first, then press "POWER" button.
- Black start: When there is no PV and grid access, turn on DC switch first, then press "POWER" button, then press and hold "B-Start" button and release it after 10s.

Startup steps:

Turn on DC switch and press the POWER switch, firstly Master LED will light up once, and then the BMS Status LED will light up for 0.5s, Operating Status LED will light up for 1s at the same time, it means that the system works normally.

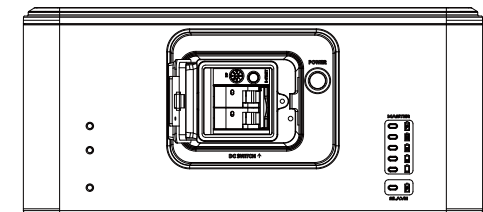

Please scan the QR Code and follow the steps below to download our latest multi-language User Manual/Quick Installation Guide:

Scan the QR Code → Select your Language → Choose to download User Manual or Quick Installation Guide → Download

